

Article number: 03508040

Description: Fluro Rod end GE 40FW-2RS

Measures

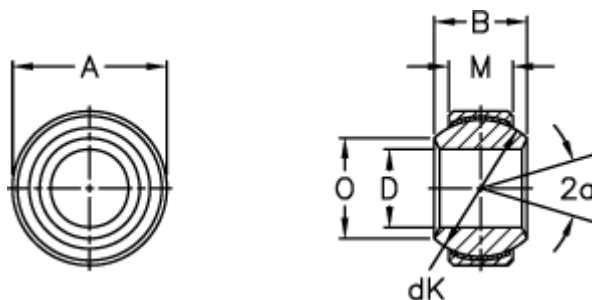

A	= 68 0 -0,013	Tilt angle = 17
B	= 40	Weight = 530
D	= 40 0 -0,012	
dK	= 60	
Dynamic load C (kN)	= 240	
M	= 25	
O	= 44.7	
Static load C0 (kN)	= 480	